

PLUG IN PARALLEL HYBRID ELECTRIC VEHICLE OR HYBRID ELECTRIC VEHICLE

S. Wahsh
Prof. of Power Electronics
Electronics Research
Institute.
Tahrir Str.Giza, Egypt.
Wahsh @eri.sci.eg

E.Abo Elzahab
Prof. of Electric Power
and Machine
Cairo University
Giza, Egypt.

M. Abd El Aziz
Prof. of Electric Power
and Machine
Cairo University
Giza, Egypt.

Y. Ahmed
Power Electronics dept.
Electronic Research Institute
Tahrir Str. Giza, Egypt
Abdelsalamyasser@yahoo.com

Abstract: Due to the high price of the fossil fuel and the aggravating environmental issues, plug-in hybrid vehicles (PHEV) have gained high popularity recently. Through proper charging and discharging processes, the PHEV fleet can act as energy storage. In this paper the performance of PHEV at different operating strategies is presented. Comparison between PHEV and Hybrid Electric Vehicles (HEV) is done and reported.

Keywords: Plug-in Hybrid Vehicles, Hybrid Electric Vehicles, Driving Cycles

1 Introduction

HEV is also classified based on their energy storage systems (ESS) as either conventional or PHEV. A normal hybrid vehicle has a small ESS which can be charged onboard. A PHEV on the other hand has a large ESS which can be charged onboard and also from an electrical outlet. The vehicle can operate in a battery mode for longer period than the conventional hybrid vehicles.

PHEV control problem is similar to the HEV control with the main difference that batteries used for PHEV applications are almost completely depleted usually 95-25 % SOC, and then charged from external sources [1].

Several simulation tools based on different modeling platforms are available, as simple electric vehicle (SIMPLEV) program and **AD**vanced **Veh**Icle **Simulat**OR (ADVISOR). In this work, the advanced vehicle simulator ADVISOR, software is used to simulate the parallel.

2 PHEV Components.

The power-train of a PHEV is composed of the following primary subsystems:

- ESS
- Electric traction motor
- Internal combustion engine (ICE)

2.1 Energy Storage System

The selection of a suitable EES plays an important role in designing a PHEV There are three factors that are considered while selecting it:

- Power rating
- Energy capacity
- Usable state of charge window.

These three factors affect the mass, cost and life of the ESS, as well as the fuel economy and performance of the vehicle.

The usable energy capacity of the ESS is defined by the desired capacity of the ESS all electric rang (AER) capability. [2].

2.2 Electric Traction Motor

The most important advantage of using an electric traction motor (EM) is that it can provide full torque at low speeds [3]. Induction motors and permanent magnet synchronous motors are generally used in electric and hybrid electric vehicles [4]. Switched reluctance motors' has excellent fault tolerant characteristics, simple construction, low manufacturing cost and excellent speed-torque characteristics suitable for PHEV applications. But it suffers from acoustic noise and torque ripple during operation, PMSM is selected in this study due its known advantages.

2.3 Internal Combustion Engine (ICE)

The ICE can be used in PHEV in two ways:

- (i) To drive the wheels in parallel configuration with the EM.
- (ii) To drive a generator for charging the battery in series configuration [5]-[8].

3 Modeling of PHEV

In this section a detailed model of each component of the PHEV is introduced using ADVISOR software program, the overall system components shown in Fig (1) will be discussed.

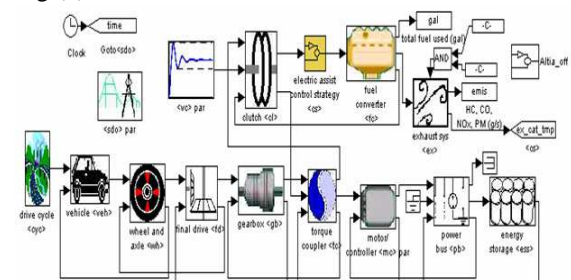

Fig (1) Model of the overall system

3.1 Vehicle Model

The analysis of the vehicle model is performed in terms of force equations based on the scalar form of Newtown's second law of motion, i.e.,

$$F = \sum M_{veh} a \dots (N) \dots \dots \dots (1)$$

The equation is expanded with the typical set of forces usually acting on the vehicles. It is rearranged to obtain the following final form [9]-[12]:

$$F_{tract} = F_{aero} + F_{roll} + F_{grad} + F_{accl} \quad (2)$$

$$F_{tract} = \frac{1}{2} \rho_{air} A_{frontal} C_D V^2 + \quad (N) \quad (3)$$

$$M_{Veh} g f_r + M_{Veh} g \sin \alpha + M_{Veh} a$$

$$P_{tract} = \frac{V}{1000 * \eta_t} \left(\frac{1}{2} \rho_{air} A_{frontal} C_D V^2 + \quad (KW) \quad (4) \right.$$

$$\left. M_{Veh} g f_r + M_{Veh} g \sin(\alpha) + M_{Veh} a \right)$$

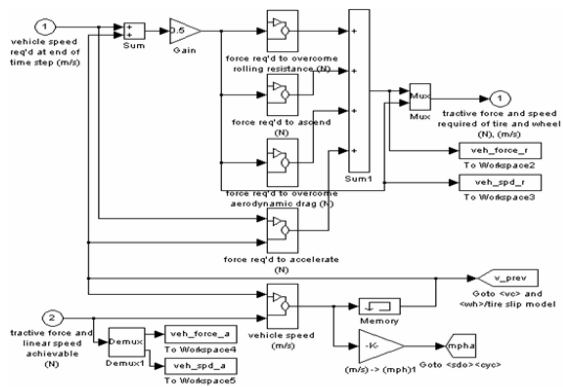

Fig.(2) Vehicle model

4 PHEV Operating Strategies.

In a parallel HEV, there is an additional source of torque available; the motor can draw electric energy from the battery to apply positive torque that accelerates the vehicle, and it can supply electric energy to the battery by applying negative torque that decelerates the vehicle.

The vehicle control strategy manages the operation of the ICE and EM systems to provide optimal vehicle performance and efficiency through every operating condition. Performance criteria include increased fuel economy and reduced emissions. The energy management system clearly divides the whole trip into Charge Depleting mode (CD) and Charge Sustaining mode (CS). Thus, the design and control techniques developed for EV and HEV can be used. PHEV facilitates using the ICE only at high efficiency since EM make it possible to switch off the ICE at low efficiency and thus use pure electric traction. [13]

The applied standard cycle in the simulation process is UUDS and HWET as a speed reference to drive a PHEV.

4.1 Charge Depletion Mode

The idea of this control strategy is to use the energy of the ESS intensively in the AER, the driver could select the pure EV mode at the start of the trip in order to fully use the energy of the energy storage to

displace the petroleum fuel, until the energy of the ESS reaches its specified level at which the CS mode will start automatically.

4.2 Charge Sustaining Mode

In charge sustaining mode, the state of charge of the ESS over a driving profile is maintained within a particular band. The engine runs to maintain the state of charge and also shares power with the EM [14]. Charge sustaining mode uses the EM in a variety of ways:

1. The motor supplies all driving torque below a certain minimum vehicle speed. See Electric Launch Speed in figure. (3).
2. The motor assists with torque if the required torque exceeds the maximum engine torque.
3. The motor charges the batteries by regenerative braking.
4. The engine shuts off when the torque request falls below a limit.

When the battery SOC is low, the engine provides excess charge torque, which passes through the motor to charge the battery (see Case 1 in fig. (3)(b)). The engine does not output a torque below a minimum torque level (Case 2). [15].

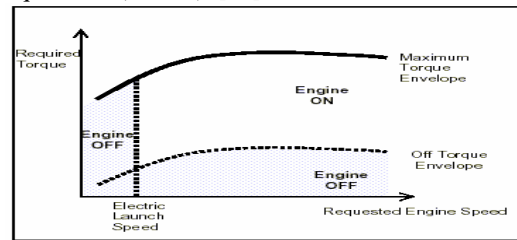

(a) Control Strategy for High SOC

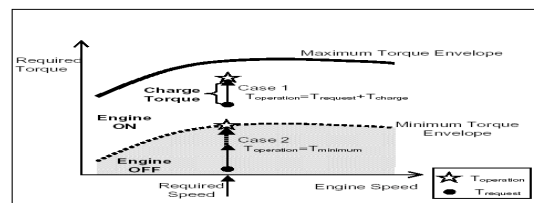

(b) Control Strategy for low SOC

Fig. (3) Charge sustaining mode control Strategy

5 Vehicle Performance Constraints.

The performance of a vehicle is usually described by its maximum cruising speed, gradeability, and acceleration which listed in table (1).

In this study the component listed in table (2) were selected from ADVISOR database as the baseline component. If an electric drivetrain efficiency of 180 WH/km is assumed then to achieve 75 km of all electric operation, a pack with 13.5 KWH of useful energy is required, assuming that only 70% of the pack capacity is usable on a daily basis then a 19.3 KWH 32 module battery pack results [16]-[17].

To determine the appropriate component sizes for this vehicle many performance aspects must be evaluated simultaneously. These include, Acceleration, Gradeability, and Electric range [18]

Table (1) Vehicle Performance Constraints

Attribute	Value	Initial/final conditions
Acceleration		
96 km/h	9.0 sec	1) initial SOC = charge sustaining SOC
64:96 km/h	4.0 sec	
Gradeability		
80 km for 15 min.	6%	1) initial SOC = 0.45 2) final SOC > 20%
AER	75 km	City driving
Maximum speed	>150 km/h	

Table (2) Vehicle Parameters Assumption

Name	Value	Unit
Vehicle mass	1620	Kg
Frontal area	1.75	m ²
Aerodynamic drag coefficient	0.3	
Coefficient of rolling resistance	0.009	
ICE		
Maximum Power	43 kW @ 4000 rpm	KW
Peak Torque	75 lb-ft @ 4000rpm.	KN
Traction motor	49.0 (continuous)	kw
Battery pack		
nominal capacity	45	Ah
Module capacity	598	WH
Module mass	8.4	Kg
Transmission		

6 Vehicle Component Sizing

6.1 Electric Range and Battery Pack Size

AER is assumed to end when the engine first turns on during a drive cycle, to achieve desired AER capability the ESS will need to provide sufficient power to propel the vehicle without assistance from ICE, fig (4) for UDDS driving cycle test and fig (5) for HYFET driving cycle, shows the ADVISOR simulation results to size the battery back appropriate to 75 km AER.

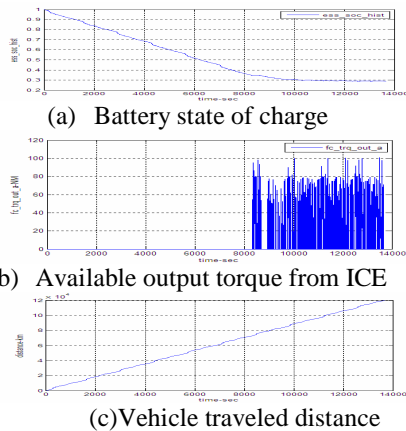

Fig.(4). Simulation result with 10 repeated UDDS cycles 120km.

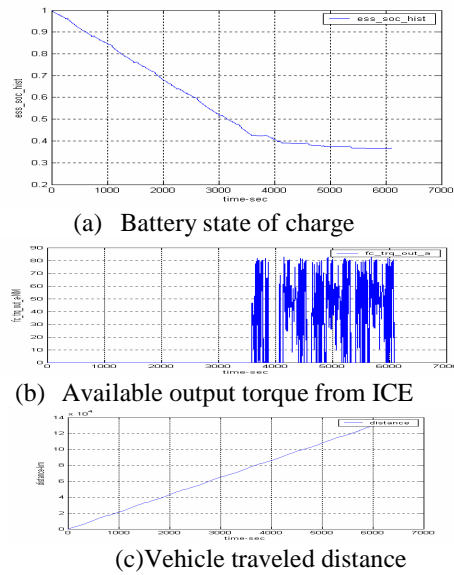

Fig (5) Simulation result with eight repeated HWFET cycles about 132 km.

6.2 Motor Sizing

In this study, the motor size was primarily defined by the drive cycle operation it should be matched to the battery pack capabilities and the vehicle must not miss the speed trace by more than 3.2 km/h at any time, as shown in fig (6) and fig (7) [19].

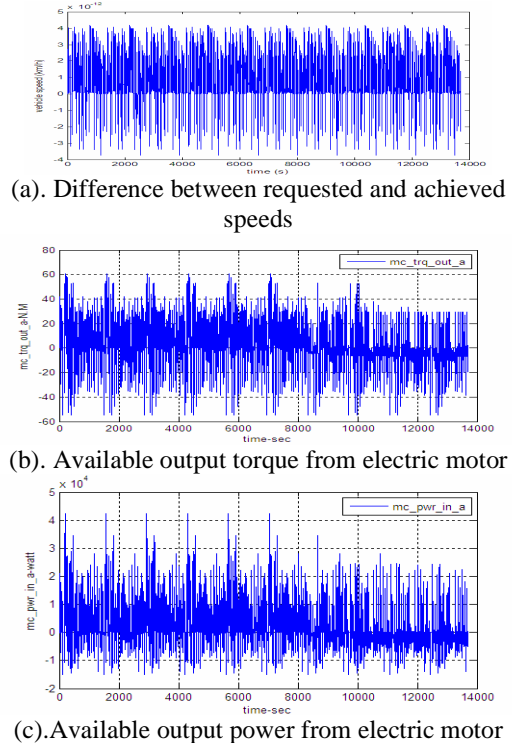
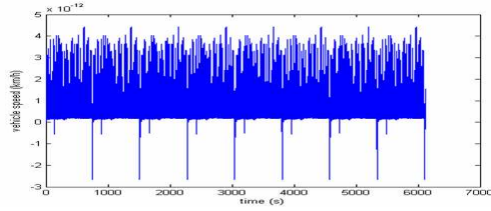
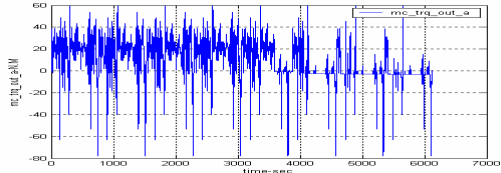

Fig (6) Simulation results after adjustment of motor size for ten repeated UDDS driving cycle



(a) Difference between requested and achieved speeds



(b) Available output torque from electric motor

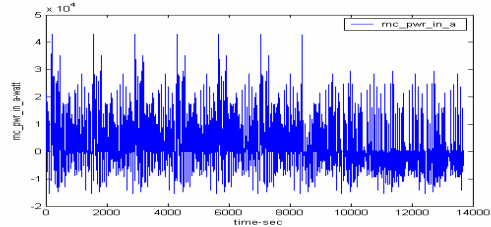

(c) Available output power from electric motor

Fig (7) Simulation results after adjustment of motor size for eight repeated HWFET driving cycle

6.3 Engine Sizing

A small engine is important to allow significant gains in operating efficiency, maintain battery SOC at required range while in charge-sustaining mode, and satisfy grade, acceleration, and drive cycle requirements, fig (8) for UDDS driving cycle test and fig (9) for HWFET driving cycle test, shows the simulation result during engine sizing to meet the vehicle requirements reported in table (2) while table (3) summarizes the final vehicle component size for all vehicle performance constrains.

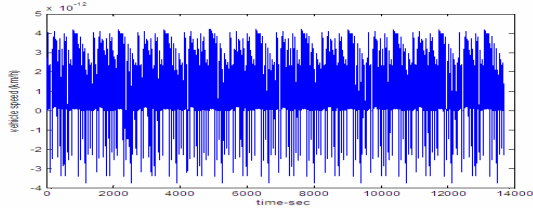

(a).Difference between requested and achieved speeds

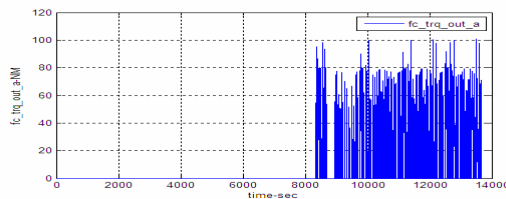

(b). ICE output torque

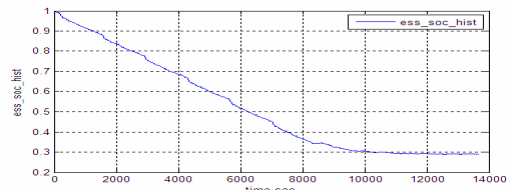

(c). Battery state of charge

Fig (8) Simulation results after adjustment of engine size ten repeated UDDS driving cycle

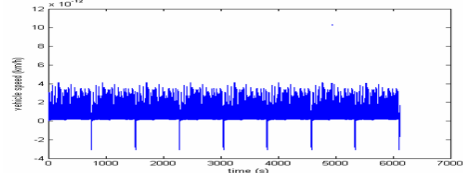

(a).Difference between requested and achieved speeds

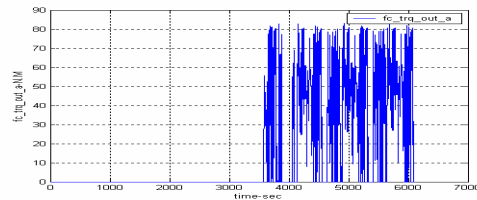

(b). ICE output torque

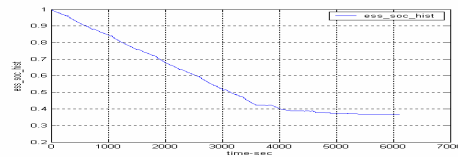

(c). Battery state of charge

Fig (9) Simulation results after adjustment of engine size for ten repeated UDDS driving cycle

Table (3) Final Vehicle Component Size for All Vehicle Performance Constrains.

Name	Value	Units
Vehicle mass	1615	Kg
ICE Maximum Power	38	KW
Motor Maximum power	45.0	KW
Battery pack		
Peak capacity	17.3	KWH
Peak power	116	KW

7 FUEL ECONOMIES AND EMISSION STUDY.

After the vehicle components were defined the next step is the optimization of control strategy parameter to minimize fuel consumption.

in this study we select 0.3 as the lowest desired SOC of battery pack parameter (cs_lo_soc), the value of highest SOC of battery pack (cs_hi_soc) is 0.58, and the load applied to the engine to recharge the battery pack (cs_charge_trq), is 16 N.m,

Now we are ready to run the vehicle simulation with the new control strategy parameters under UDDS cycle test and HWFY cycle to study and compare the fuel consumption and emissions with conventional HEV. In this simulation the initial SOC was set to 1.0 (complete battery charged), the simulation result show the vehicle run in EV mode (CD mode) for the time interval $t = 0:8350$ sec and cut 75 km, the vehicle run in the hybrid mode (CS mode) for the time interval $8350 \text{ sec} \leq t \leq 13000$ sec.

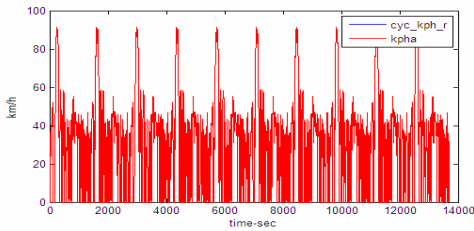

(a) Actual vehicle speed and reference speed for ten repeated UDDS cycles

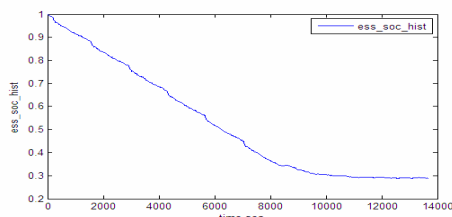

(b) Battery pack SOC history

Fig (9) PHEV simulation results for a ten repeated UDDS cycle test

Figure (9)(a) shows a 10 repeated UDDS cycles as references vehicle speed and the actual vehicle speed, the difference between requested and achieved speeds is negligible, which means the vehicle component sizing, can meet the required loads in both CS/CD modes. Figure(17)(b) shows the SOC history, the initial SOC was set to 1.0 and reduced gradually until reach its predetermined threshold value 0.3, the control strategy system tray to maintain the SOC at this value by recharging the battery system during braking by regenerative or during light ICE loads to improve its efficiency.

Figures (10)(a) and (b) show the available torque from ICE and EM for vehicle propelling, during the first 8380 sec the ICE was not activated, only the EM produce torque to propel the vehicle until the battery reach its predetermined threshold value ($cs_lo_soc=0.3$), during this period the most of motor torque is positive.

ICE was activated at $t = 8350$ to be the dominant during the remaining time in the trip, during this period the PHEV working as conventional HEV, the EM used to assist the ICE to propel the vehicle and

maintain the SOC by regenerative braking or from ICE during idling or light loading.

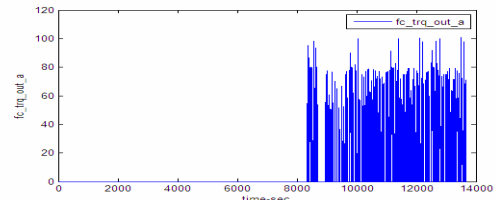

(a) ICE output torque

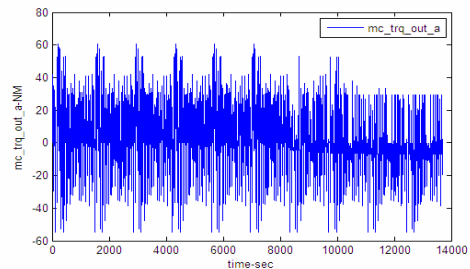

(b) Motor output torque

Fig (10) Torque available of motor and ICE for ten repeated UDDS cycle test

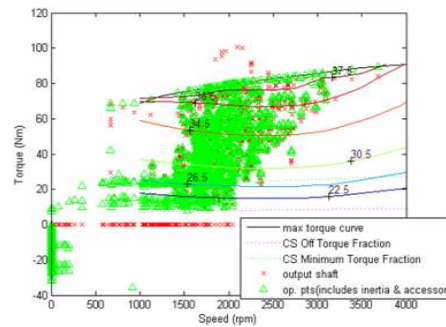

(a) ICE operation

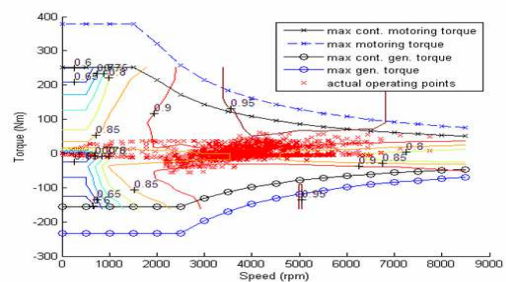

(b) Motor/controller operation

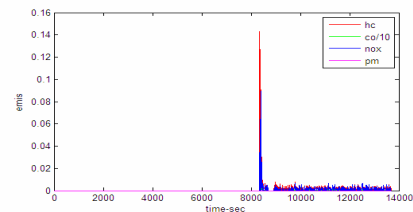

(c) ICE emissions

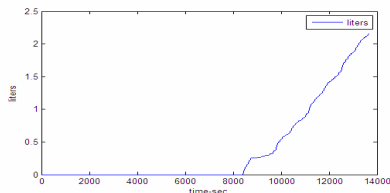

(d)

(d) ICE consumed fuel

Fig (11) ICE and motor operation in case of ten repeated UDSS test

Figures (11) (a) shows ICE operating points (efficiency maps), the operating points of ICE are adjusted near the optimal operating region [20] Figure (11)(b) shows the motor operating points of the parallel PHEV are more concentrated in the extended high-speed high-efficiency region, In addition, taking regenerative braking into consideration, as is clear the regenerative braking events take place in high efficiency region (85% - 90%). Figure (11)(c) and (d) show the ICE emissions and consumed fuel respectively which will be reported and compared latter, the liquid fuel consumed by ICE was 2.18 liter as shown. The total equivalent fuel consumed can be calculated from equation (5) [9].

Fuel economy (FE)

$$FE = \frac{\text{distance}}{\text{fuel volume} + \text{ESS equivalent fuel volume}} \quad (\text{km/liter}) \quad (5)$$

$$FE = \frac{D}{V_f + \frac{E_{\text{charge}}}{E_{\text{gasoline}}}} \quad (\text{km/liter}) \quad (5)$$

33.9 (km/liter) = 2.94(liter /100 km)

For UDSS driving cycle the fuel volume consumed was 2.16 liter, the trip distance was 120 km and 12.14 KWH used energy from battery, which give 33.98 km/liter or 2.94 liter/100 km.

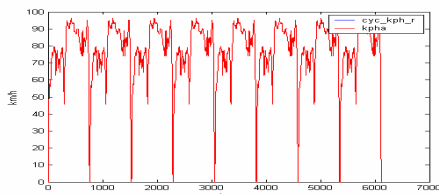

(a) Actual vehicle speed and reference speed for Eight repeated HWFET .

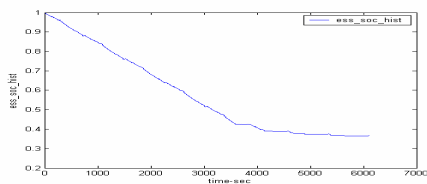

(b) Battery pack SOC history

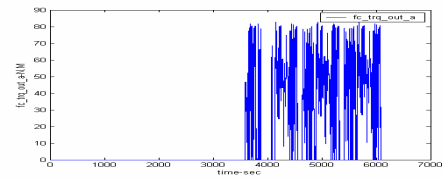

(c) ICE output torque

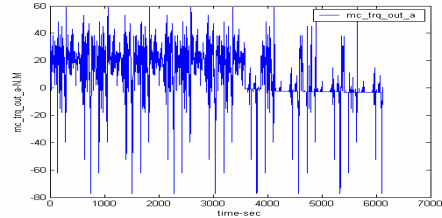

(d) Motor output torque

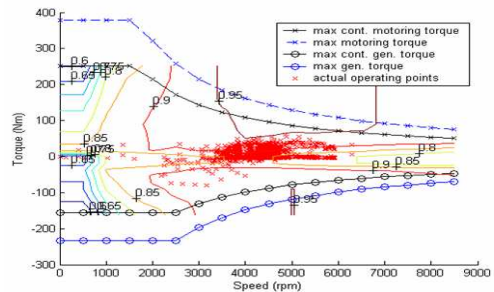

(e) Motor operation

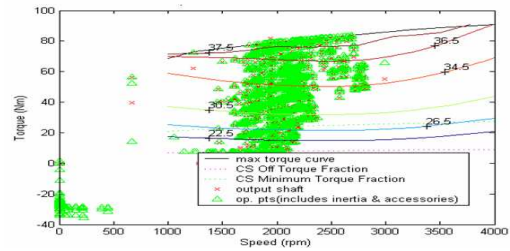

(f) ICE operation

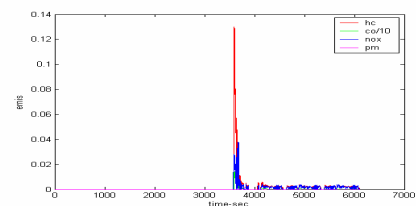

(g) ICE emissions

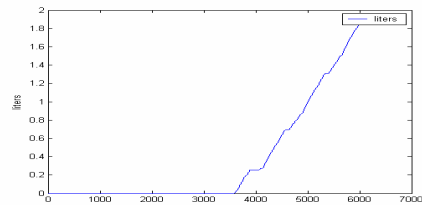

(h) ICE consumed fuel

Fig (12) PHEV simulation results for eight repeated HWFET cycles test.

Figure (12) shows the simulation results for HWFET cycle, the PHEV working in CD mode for the first 3700 sec time interval, the ICE was not activated, only the EM produce torque to propel the vehicle. ICE was activated during the remaining period of the trip and the PHEV working as conventional HEV, the EM used to assist the ICE to propel the vehicle and maintain the SOC by regenerative.

The fuel volume consumed by ICE was 1.96 liter fig(12)(h), the trip distance was 132 km, and 10.9 KWH used energy from ESS at 0.37 final state of charge which give 41.25 km/liter or 2.42liter/100km, the total emission will be reported in table (4).

$$FE = \frac{D}{V_f + \frac{E_{charge}}{E_{gasoline}}} = FE = \frac{132}{1.96 + \frac{10.9}{44}} = 41.25 \text{ km/liter} = 2.42 \text{ liter/100km}$$

41.25 km/liter = 2.42 liter/100km

8 CONVENTIONAL HEV SIMULATIONS

With the same component size of parallel PHEV, a simulation will be done to compare the fuel consumption and emissions of PHEV and conventional parallel HEV for the same trip length and driving cycle.

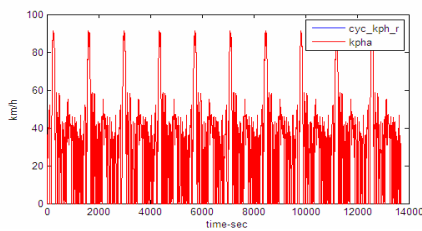

(a) Actual vehicle speed and reference speed for ten repeated UDDS cycles

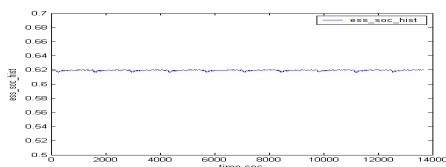

(b) Battery pack SOC

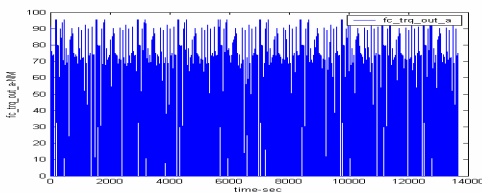

(c) ICE available torque

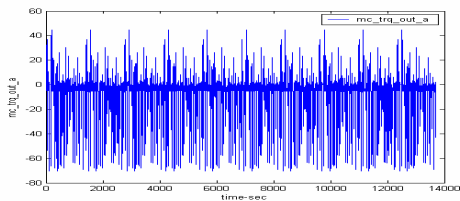

(d) Electric motor available torque

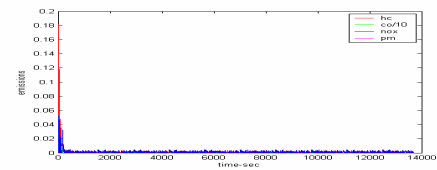

(e) ICE emissions

Fig (13) HEV Simulation results for 10 repeated UDDS cycles test.

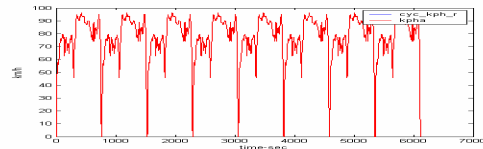

(a) Actual vehicle speed and reference speed for eight repeated HWFET

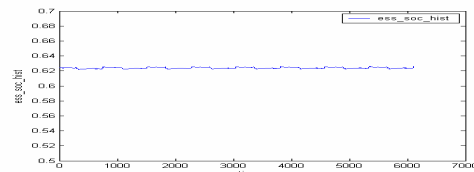

(b) Battery pack SOC

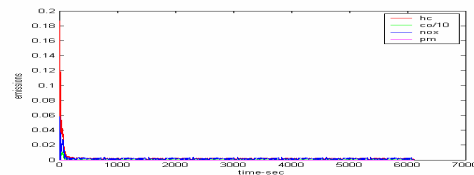

(c) ICE emissions

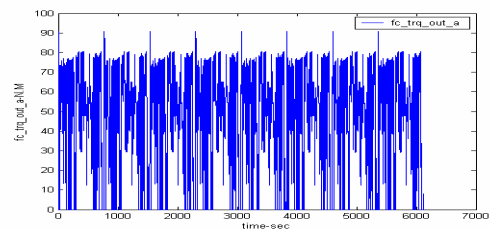

(d) ICE available torque

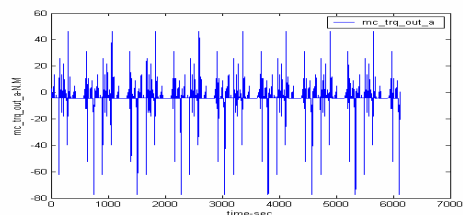

(e) Electric motor available torque

Fig (14) HEV simulation results for 8 repeated HWFET cycle test.

The simulation results for parallel HEV for UDDS driving cycle test fig(13) and HWFET driving cycle test fig(14), the ICE was activated from the first second, the EM working to assist the ICE during peak loads, the initial and final value of SOC for battery pack was maintained at the same level.

The total fuel consumption during the trip was 6.49 liter for 120 km trip length in case of UDSS cycle test, and 5.45 liter for 132 km in case of HWFET, the total emission reported in the tables (4) and (5).

Table (4) fuel consumption and emissions for UDSS cycle test.

	PHEV			HEV			Fuel and emissions saving		
Fuel (liter/100 km)	3.45			5.41			36.2%		
Emissions (gram/km)	HC	CO	NOx	HC	CO	NOx	HC	CO	NOx
	.12	.15	.05	.21	.215	.089	40.8	26.1	37.1

Table (5) fuel consumption and emissions for HWFET cycle test.

	PHEV			HEV			Fuel and emissions saving		
Fuel liter/100km	2.42			4.13			41.4%		
Emission gram/km	HC	CO	NOx	HC	CO	NOx	HC	CO	NOx
	.07	.10	.03	.13	.16	.086	44.4	38.5	54.65

CONCLUSION

The control strategy for PHEV resulted in a 36.2 % saving of fuel consumption for UDSS cycle and 41.4 % for HWFET over the conventional HEV for the same trip length and component size. The emissions reduced significantly by replacing the conventional HEV by the PHEV as reported in tables (4) and (5).

Reference

1. P. Tulpule, V. Marano and G. Rizzoni, "Effects of Different PHEV Control Strategies on Vehicle Performance" American Control Conference, St. Louis, MO, USA 10-12 June 2009.
2. T. Markel and A. Simpson "Plug-In Hybrid Electric Vehicle Energy Storage System Design," National Renewable Energy Laboratory, NREL/CP-540-39614, May 2006.
3. I. Husain, Electric and Hybrid Vehicles, Design Fundamentals, CRC, 2003
4. J.M. Miller, Propulsion Systems for Hybrid Vehicles, IEE, 2004.
5. G. Jinwen, S. Jian, and D. Yongchang, "Mode and Control Strategy of HEV Equipped with EVT" IEEE Conference on Vehicle Power and Propulsion, VPPC '09. 7-10 Sept. 2009, PP1822:1825.
6. Z. Rahman, M. Ehsani, and K. Butter, "An Investigation of Electric Motor Drive Characteristics of EV and HEV propulsion System" Future Translation Technology Conference, Costa Mesa, California, 21:23 Aug. 2000.
7. S. Moura, H. Fathy, D. Callaway, and J. Stein, "A Stochastic Optimal Control Approach for Power Management in Plug-In Hybrid Electric Vehicles" Proceedings of the 2008 ASME Dynamic Systems and Control Conference (DSCC 2008), Michigan, October 2008.
8. S.Wahsh, M.Abdelaziz and Y.Ahmed "Fuzzy Type 2 Controller for Different Direct Torque Control PMSM Drives Using Space Vector Techniques" European Journal of Scientific Research (Jee) Volume 13 / 2013 - Edition : 4, pp 95-103
9. M. Ducusin, S. Gargies, and C. Mi, "Modeling of a Series Hybrid Electric High-Mobility Multipurpose Wheeled Vehicle" IEEE Conference on Vehicular Technology, Vol. 56, No. 2, MAR. 2007, pp 557:565.

10. Z. Song, W. Guangqiang1, and Z. Songlin, "Study on the Energy Management Strategy of DCT-based Series-Parallel PHEV", 2010 International Conference on Computing, Control and Industrial Engineering.
11. A. Salisa, N. Zhang, and J. G. Zhu "A Comparative Analysis of Fuel Economy and Emissions between a Conventional HEV and the UTS PHEV", IEEE Trans on Vehicular Technology, Vol. 60, No. 1, Jan. 2011
12. H. Yu, R. Lu, T. Wang, and C. Zhu," Battery/ultra-capacitor Hybrid Energy Storage System Used in HEV", Journal of Asian Electric Vehicles, Volume 8, Number 1, June 2010, pp 1351:1356.
13. P. Fajri and B. Asaei, "Plug-in Hybrid Conversion of a Series Hybrid Electric Vehicle and Simulation Comparison" Optimization of Electrical and Electronic Equipment, 2008. OPTIM 2008. 11th International Conference on Digital Object Identifier: 10.1109/OPTIM.2008.4602422, PP(s): 287 – 292
14. A Rule-Based Energy Management Strategy for Plug-in Hybrid Electric Vehicle (PHEV) Harpreetsingh Banvait, Sohel Anwar, Member, ASME, and Yaobin Chen, Member, IEEE, 2009 American Control Conference Hyatt Regency Riverfront, St. Louis, MO, USA June 10-12, 2009 pp 3938:3934.
15. Tony Markela and Keith Wipkea, "Modeling Grid-Connected Hybrid Electric Vehicles Using ADVISOR" National Renewable Energy Laboratory, NREL/CP-540-30601
16. S.Wahsh, "Smart Grids Plug-In-Hybrid Electric Vehicle Integration", 3rd conf. on Advanced Control Circuits and Systems (ACCS) CD, 30 Nov.-3 Dec., 2013, Luxor, Egypt
17. S. M. A. Faisal, "Grid Connected Photovoltaic System Using MATLAB/SIMULINK", Journal of Electrical Engineering: Volume 12 / 2012 - Edition: 4, pp 25-36
18. C. Lv, J. Zhang, "Research of Parameter Design and Matching of power System in Plug-in Hybrid Electric Vehicle", International Conference on Electric Information and Control Engineering (ICEICE), 15-17 April 2011, PP 2490:2493.
19. D. M. M. G.M., "Design Methodology for Range Extended PHEV", IEEE Vehicle Power and Propulsion Conference, 2009. VPPC '09, 7-10 Sept. 2009, 817 - 819
20. H. Valerie J, Keith B. Wipke and D. Rausen, "HEV Control Strategy for Real-Time Optimization of Fuel Economy and Emissions", SAE Technical Paper, 2000-01-1543.

List of Symbols:

a	Acceleration.
D	Trip distance by kilometer, E_{charge} total energy consumed from battery kWh
$E_{gasoline}$	a constant equal 8.8 kWh/liter, representing the energy content in one liter of gasoline
E_{usable}	Useable energy, in the energy storage,
F	Driving force on the wheel
F_{accel}	Force required for vehicle acceleration
F_{tract}	Force generated by ICE or EM
P_{aux}	Power required for auxiliary loads
P_b	battery power
P_m	Power from battery of EM
P_{tract}	Traction power
SOC_{max}	Max SOC with fully charged energy storage
SOC_{min}	SOC of the energy storage at which the operation mode is switched from the pure EV or CD mode to the CS mode.
T	Output torque of EM
w	Angular velocity of EM
η_{be}	efficiency of battery and power electronic components
η_m	motor efficiency
η_t	Overall efficiency from wheels to the ICE or EM.